

BOCA RATON, FL

GLADES PLAZA

LEASING PLAN

2200-2300 Glades Rd. & 2240 NW 19th St.

Boca Raton, FL 33431

< Traffic light at Butts Road

Interstate-95 (205,000 cars per day) >

Glades Road (62,000 cars per day)

- N
- ± 23.3 acres
- pylon
- 2nd Generation Restaurant Space

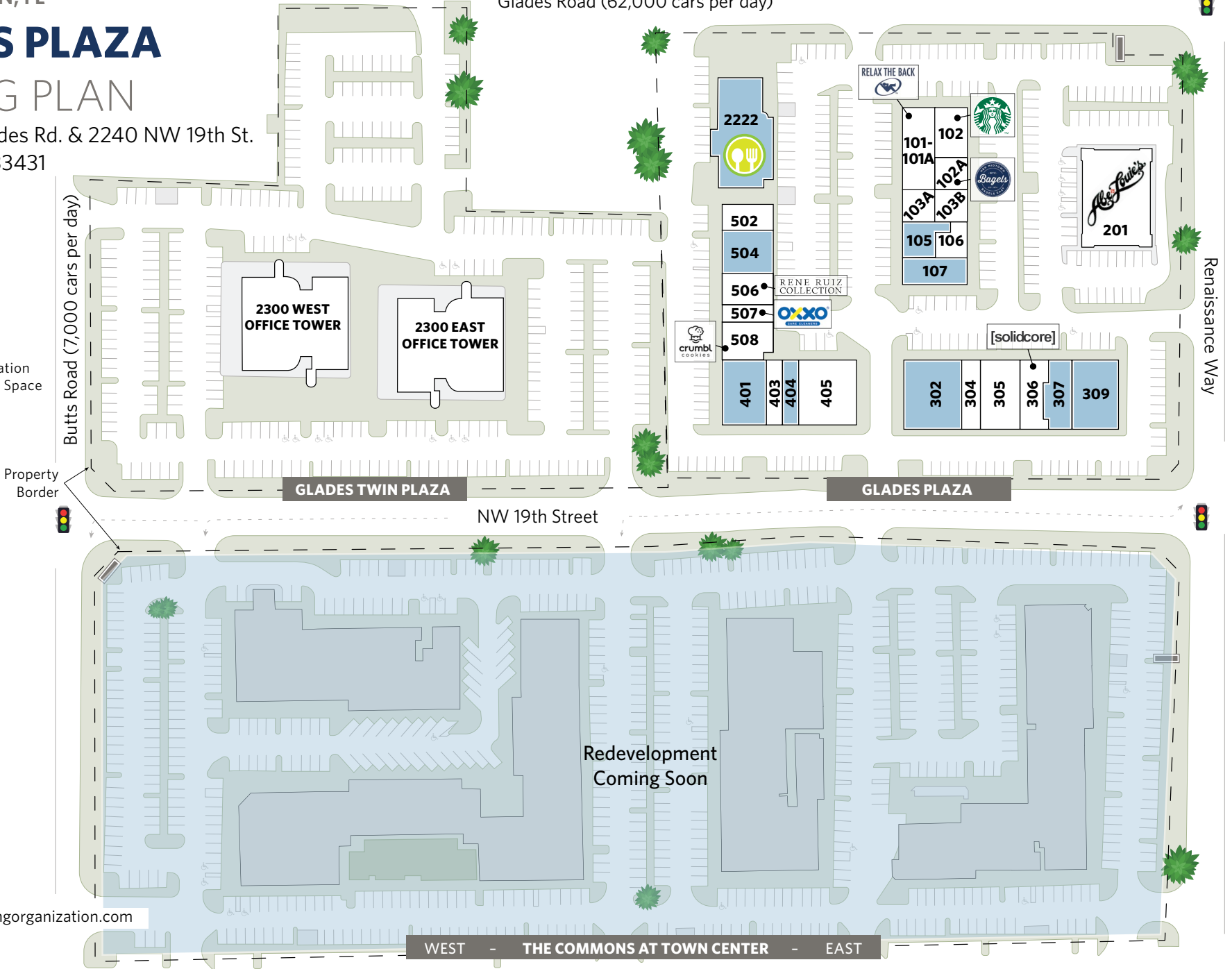

TOWN CENTER AT BOCA RATON

For information:
Chris Rogers

E: crogers@sterlingorganization.com
P: 855-909-4012



The plan and its contents are furnished for informational purposes only and are intended only as a general description (but not represented, covenanted or warranted). The size and location of the project, the identity or nature of any occupant and all features, matters and other information included herein are subject to change without notice and should not be relied upon by any party. No representation or warranty, express or implied, is made as to the accuracy or reliability of this plan or its contents.

GLADES PLAZA

LEASING PLAN

2200-2300 Glades Rd. & 2240 NW 19th St.

Boca Raton, FL 33431

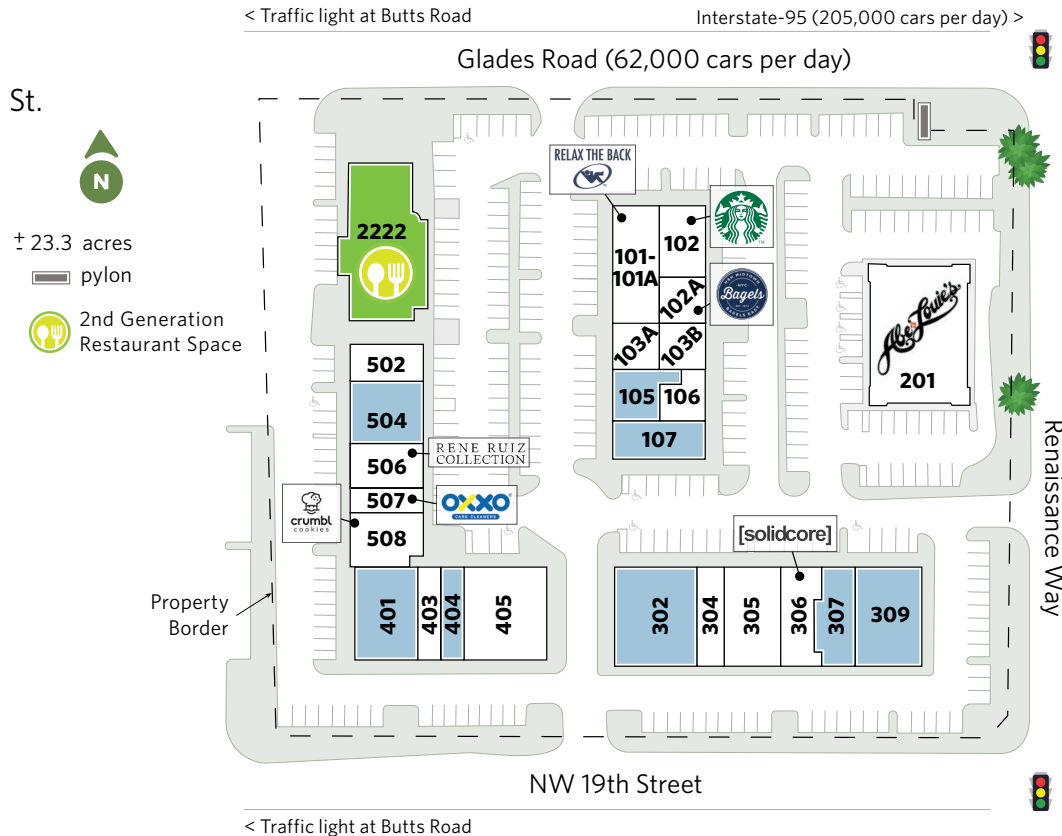

For information:

Chris Rogers

E: crogers@sterlingorganization.com

P: 855-909-4012

UNIT	RETAIL TENANT	SQ. FT.	UNIT	RETAIL TENANT	SQ. FT.	UNIT	RETAIL TENANT	SQ. FT.	UNIT	RETAIL TENANT	SQ. FT.
GLADES PLAZA			GLADES PLAZA			GLADES PLAZA			GLADES PLAZA		
101-101A	Relax the Back	3,116	107	Available	1,990	307	Available	1,877	504	Available	3,121
102A	H&H Bagels	1,226	201	Abe & Louie's	7,457	309	Available	4,479	506	Rene Ruiz	2,045
102	Starbucks	2,000	302	Available	4,931	401	Available	3,881	507	OXXO Care Cleaner	1,095
103A	Fitlife Foods	1,137	304	SIA Specialty Infusion and Wellness Spa	1,339	403	Raw Juice	1,363	508	Crumbl Cookies	1,498
103B	Closet Full of Linens	1,078	305	Ideal Image	3,039	404	Available	1,323	2222	Available	7,091
105	Available	1,858	306	Solidcore	1,863	405	Flying Lizard	4,025	Glades Plaza Total Square Feet: 65,757		
106	Holistic Nails	1,325	502	LaSpada's Hoagie Cafe	1,600						

GLADES TWIN PLAZA LEASING PLAN

2200-2300 Glades Rd. & 2240 NW 19th St., Boca Raton, FL 33431

For information:

Chris Rogers

E: crogers@sterlingorganization.com

P: 855-909-4012

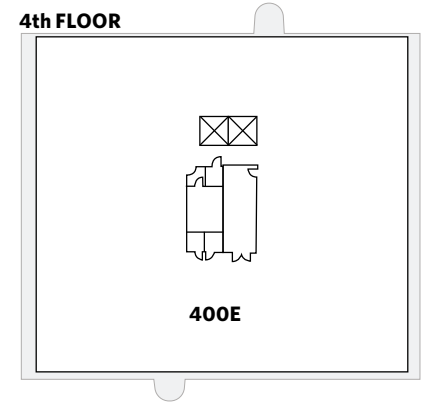
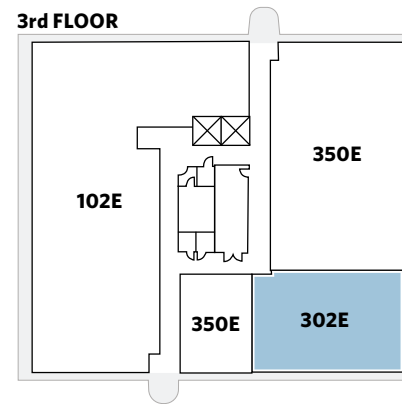
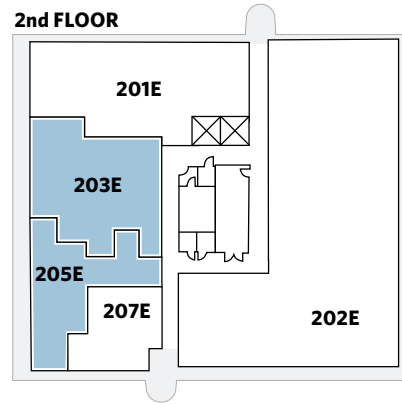
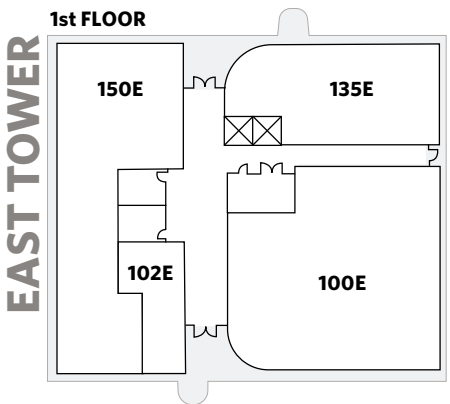
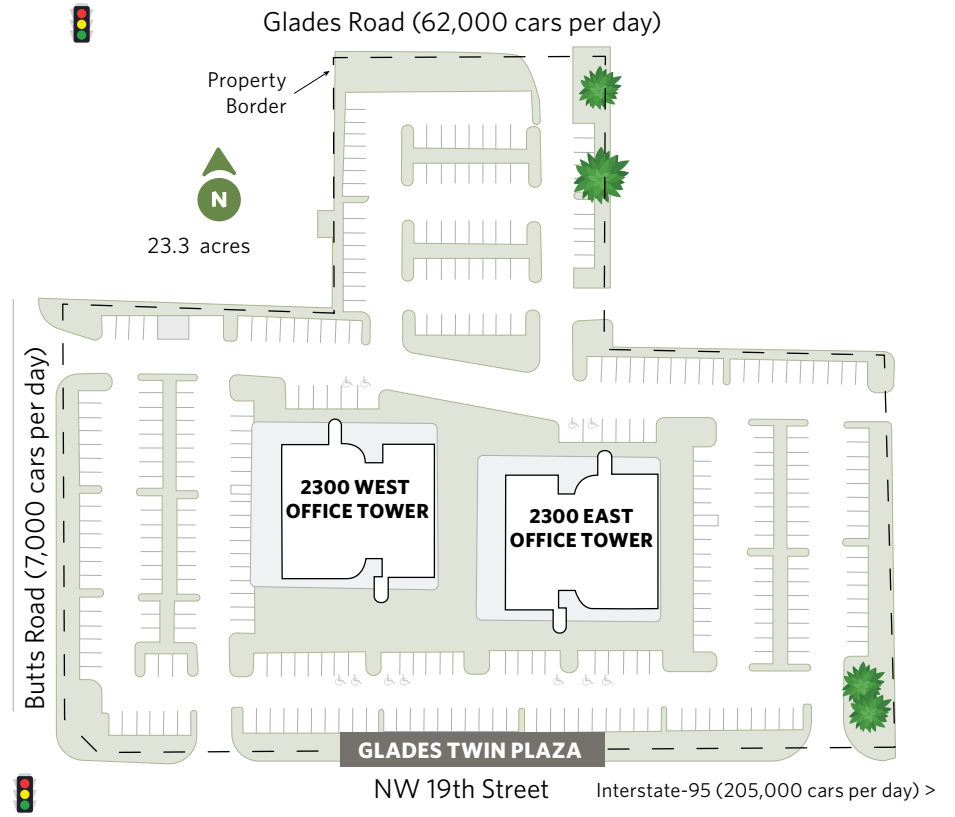
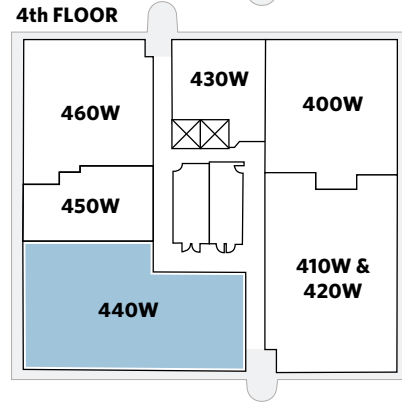
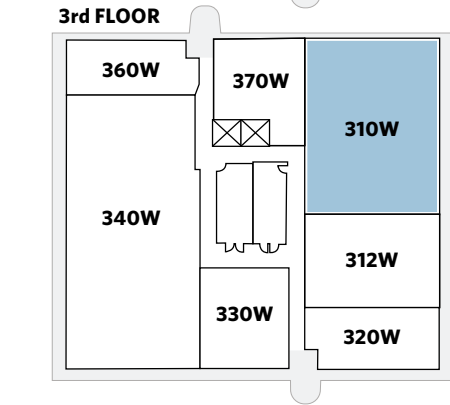
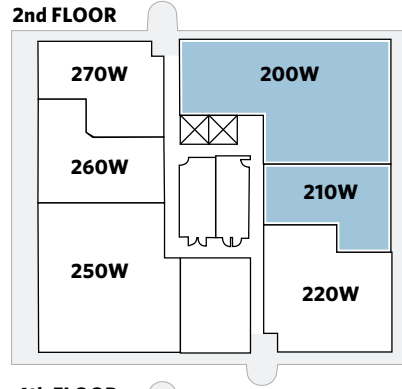
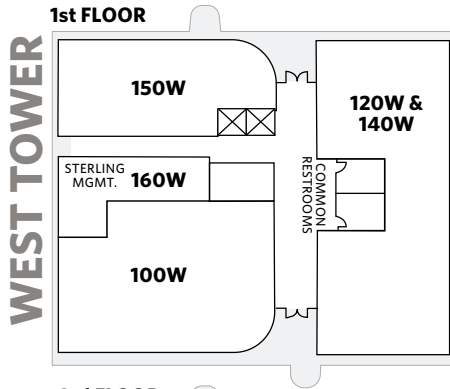

COMMONS AT TOWN CENTER LEASING PLAN

2200-2300 Glades Rd. & 2240 NW 19th St.
Boca Raton, FL 33431

For information:

Chris Rogers

E: crogers@sterlingorganization.com
P: 855-909-4012

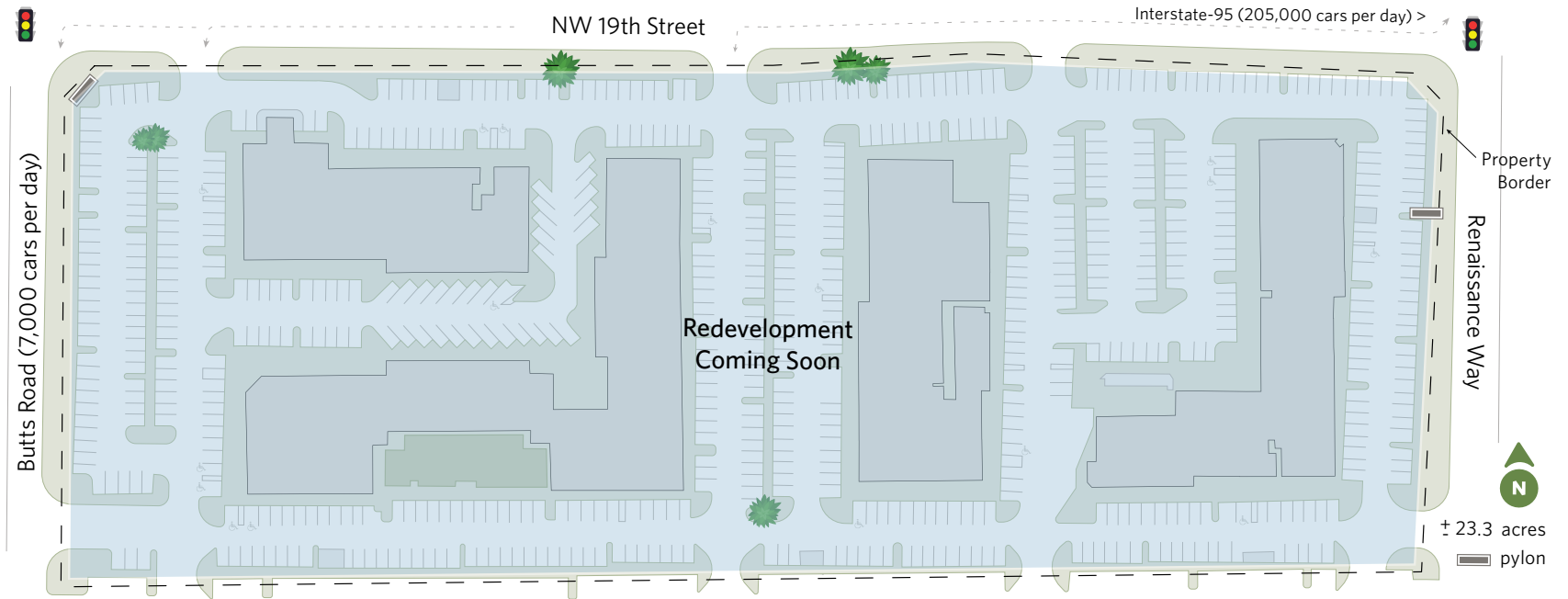

UNIT	RETAIL TENANT	SQ. FT.
THE COMMONS AT TOWN CENTER - WEST		
601	Barbara Katz Sportswear Co.	9,368
604	Yoga Journey	3,304
609	Available	1,467
611	Available	1,990
613	Available	4,404
614	LaSpada's Hoagie Cafe	1,368

UNIT	RETAIL TENANT	SQ. FT.
THE COMMONS AT TOWN CENTER - WEST		
700	Toojay's	5,300
701	Available	4,450
703	Available	9,822
800A	Available	4,000
800B	Available	11,384
807	Available	5,861

The Commons at Town Center - WEST
Total Square Feet: 62,718

UNIT	RETAIL TENANT	SQ. FT.
THE COMMONS AT TOWN CENTER - EAST		
900	Five Guys	2,694
901	Available	2,577
904	Nicks New Haven Pizza	4,747
907	Available	1,235
908-911	Available	4,570
912	Available	1,951
913	Available	1,008
914.916	Casa de Montecristo	4,557
915	Available	3,263
1101	Available	1,730
1101A	Available	5,500
1101B	Available	1,656

UNIT	RETAIL TENANT	SQ. FT.
THE COMMONS AT TOWN CENTER - EAST		
1101C	Available	500
1102	Premier Championship Cheerleading	3,000
1103	Salon Chenzo	2,258
1200	Available	2,944
1200B	Moe's Southwest Grill	2,504
1201	Available	3,168
1203	Available	1,242
1204	Available	1,238
1205	Available	1,235
1206	Man Cave	1,500

The Commons at Town Center - EAST
Total Square Feet: 55,077

GLADES PLAZA LEASING PLAN

2200-2300 Glades Rd. & 2240 NW 19th St., Boca Raton, FL 33431

UNIT	OFFICE TENANT	SQ. FT.
GLADES TWIN PLAZA - WEST OFFICE TOWER		
100-140W	Seacoast National Bank	6,835
150W	PrimeLending	1,852
160W	Mgmt. Office	-
200W	Available	3,437
210W	Available	1,340
220W	F&V Capital Management	2,020
230W	First Alliance Group	950
250W	Alliant Insurance	2,694
260W	Sentinel Private Wealth	1,499
270W	Paul Ghougasian, P.A.	1,600
310W	Available	2,419
312W	CaseClients	1,502
320W	CB Recovery Group	1,735
330W	Priscila Iwama Medical and Cosmetic Dermopigmentation	1,117
340W	Lydecker Diaz	4,650
360W	USGB Enterprises	921
370W	Lydecker Diaz	1,090
400-420W	Wrathell, Hunt & Associates	5,884
430W	JB Law	800
440W	Available	3,296
450W	Wrathell Hunt & Associates (Coming Soon)	1,079
460W	Wrathell Hunt & Associates	2,381

UNIT	OFFICE TENANT	SQ. FT.
GLADES TWIN PLAZA - EAST OFFICE TOWER		
100E	Cutiscare	3,993
102E	Deluxe Financial	5,558
135E	Zucker & Associates, P.A.	1,885
150E	NuLife Institute	2,399
201E	Gastro Health	2,694
202E	ISO Management	6,639
203E	Available	1,506
205E	Available	1,148
207E	Garber & Garber, CPAs, P.A.	819
302E	Available	1,854
350E	Anxiety Institute	6,775
400E	Torticity	13,455

Total Office Square Feet: 97,826

UNIT	RETAIL TENANT	SQ. FT.
GLADES PLAZA		
101-101A	Relax the Back	3,116
102A	H&H Bagels	1,226
102	Starbucks	2,000
103A	Fitlife Foods	1,137
103B	Closet Full of Linens	1,078
105	Available	1,858
106	Holistic Nails	1,325
107	Available	1,990
201	Abe & Louie's	7,457
302	Available	4,931
304	SIA Specialty Infusion and Wellness Spa	1,339
305	Ideal Image	3,039
306	Solidcore	1,863

UNIT	RETAIL TENANT	SQ. FT.
GLADES PLAZA		
307	Available	1,877
309	Available	4,479
401	Available	3,881
403	Raw Juice	1,363
404	Available	1,323
405	Flying Lizard	4,025
502	LaSpada's Hoagie Cafe	1,600
504	Available	3,121
506	Rene Ruiz	2,045
507	OXXO Care Cleaner	1,095
508	Crumb Cookies	1,498
2222	Available	7,091

Glades Plaza Total Square Feet: 65,757

UNIT	RETAIL TENANT	SQ. FT.
THE COMMONS AT TOWN CENTER - WEST		
601	Barbara Katz Sportswear Co.	9,368
604	Yoga Journey	3,304
609	Available	1,467
611	Available	1,990
613	Available	4,404
614	LaSpada's Hoagie Cafe	1,368
700	TooJay's	5,300
701	Available	4,450
703	Available	9,822
800A	Available	4,000
800B	Available	11,384
807	Available	5,861

The Commons at Town Center West - Total Square Feet: 62,718

UNIT	RETAIL TENANT	SQ. FT.
THE COMMONS AT TOWN CENTER - EAST		
900	Five Guys	2,694
901	Available	2,577
904	Nicks New Haven Pizza	4,747
907	Available	1,235
908-911	Available	4,570
912	Available	1,951
913	Available	1,008
914.916	Casa de Montecristo	4,557
915	Available	3,263
1101	Available	1,730
1101A	Available	5,500
1101B	Available	1,656
1101C	Available	500
1102	Premier Championship Cheerleading	3,000
1103	Salon Chenzo	2,258
1200	Available	2,944
1200B	Moe's Southwest Grill	2,504
1201	Available	3,168
1203	Available	1,242
1204	Available	1,238
1205	Available	1,235
1206	Man Cave	1,500

The Commons at Town Center East - Total Square Feet: 55,077

Total Retail Square Feet: 183,552
Total Square Feet: 281,378

For information:

Chris Rogers

E: crogers@sterlingorganization.com
P: 855-909-4012



The plan and its contents are furnished for informational purposes only and are intended only as a general description (but not represented, covenanted or warranted). The size and location of the project, the identity or nature of any occupant and all features, matters and other information included herein are subject to change without notice and should not be relied upon by any party. No representation or warranty, express or implied, is made as to the accuracy or reliability of this plan or its contents.